

2804-U3A -
Portaimpronta forati in acciaio inox - PERMA-LOCK
ANATOMIC / Perforated stainless steel impression trays -
PERMA-LOCK ANATOMIC

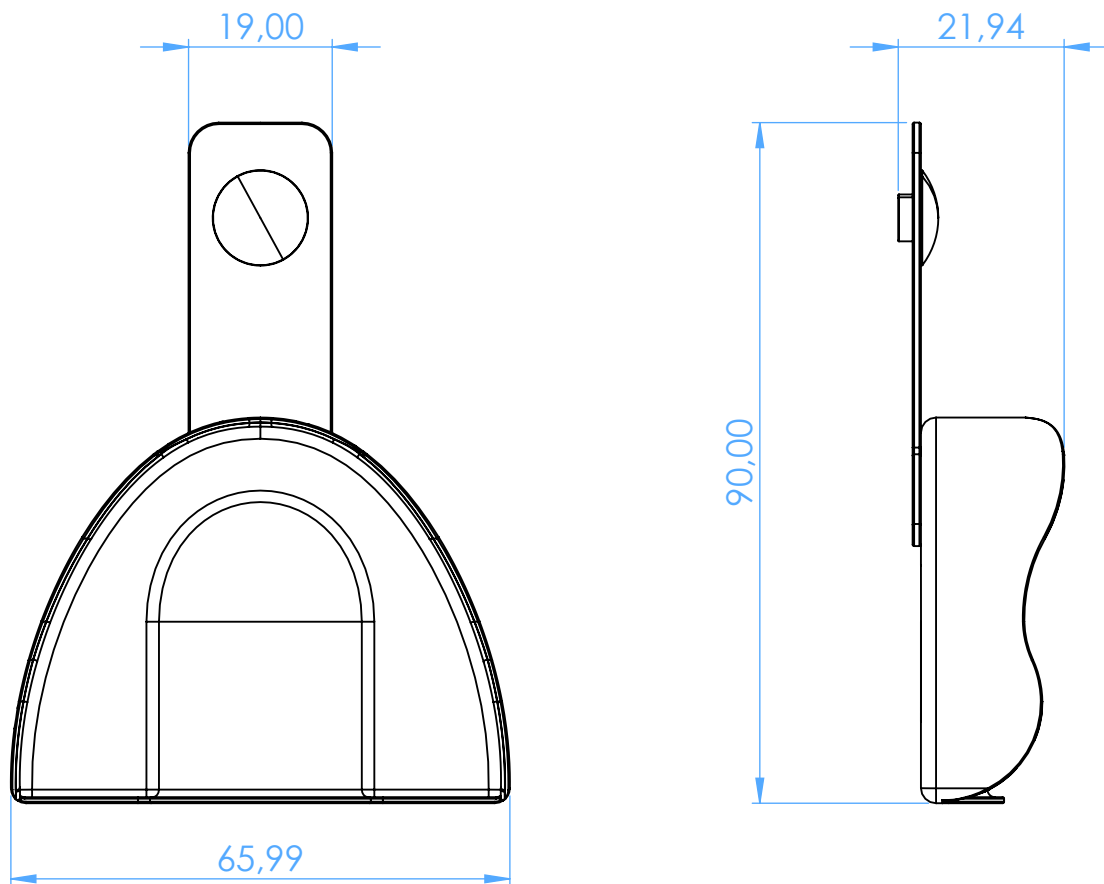

SCALE 1:1