

2809-U4 -
Portaimpronta forati in acciaio inox - depressi
anteriormente / Perforated stainless steel impression
trays - anterior depressed

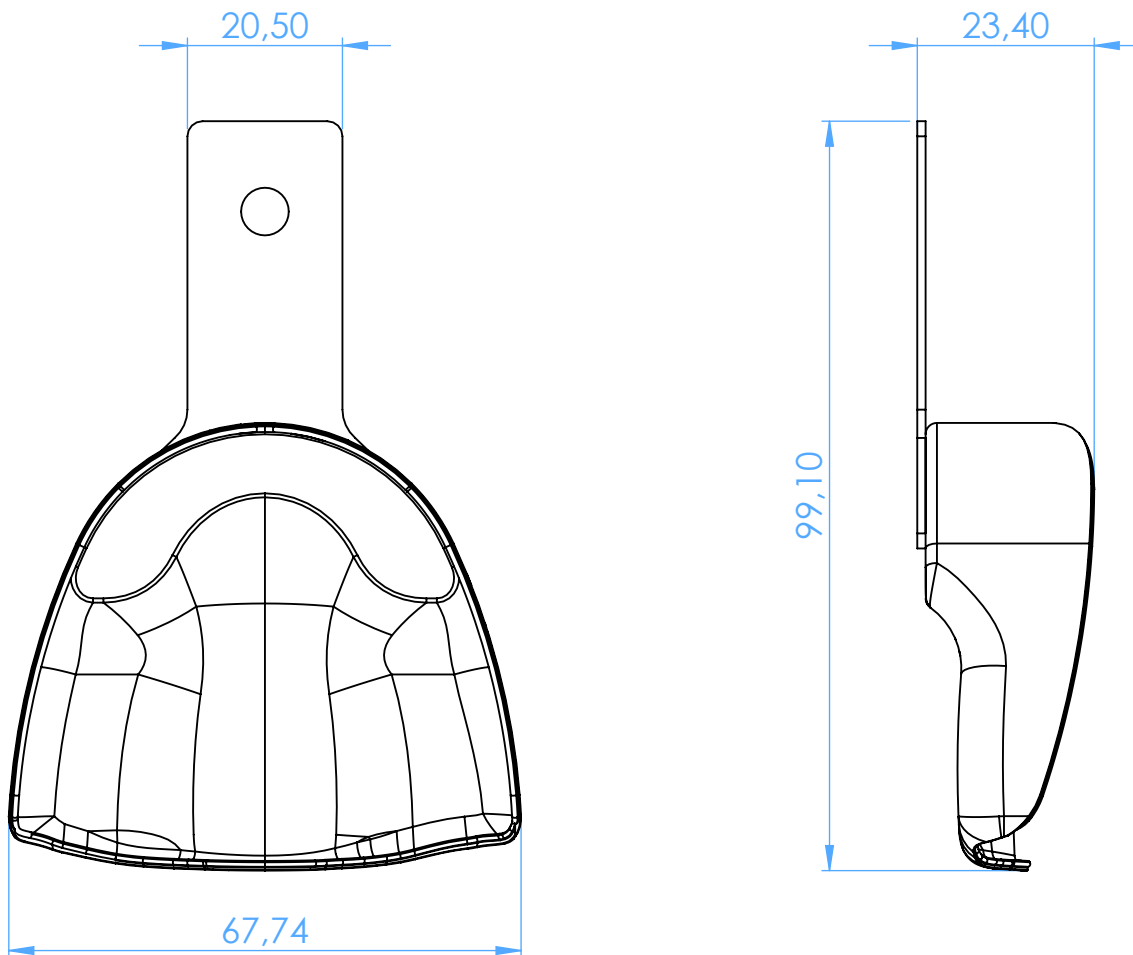

SCALE 1:1