

3052-2A - RUBBER DAM CLAMPS / Uncini per diga

2A winged

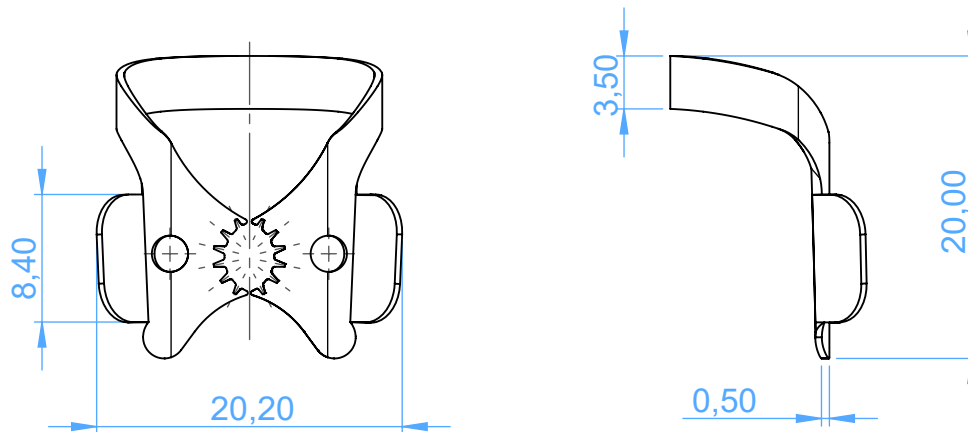

SCALE 2:1