

3052-3 - RUBBER DAM CLAMPS / Uncini per diga

3 winged

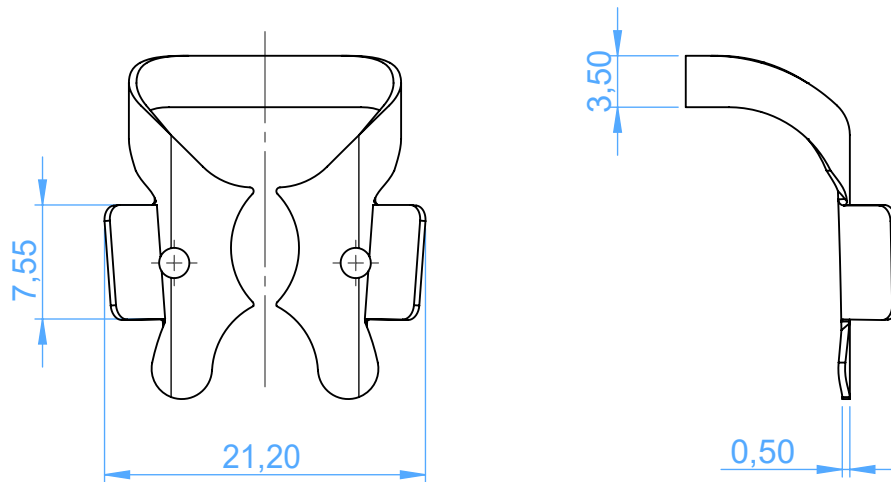

SCALE 2:1