

3052-8 - RUBBER DAM CLAMPS / Uncini per diga

8  
winged

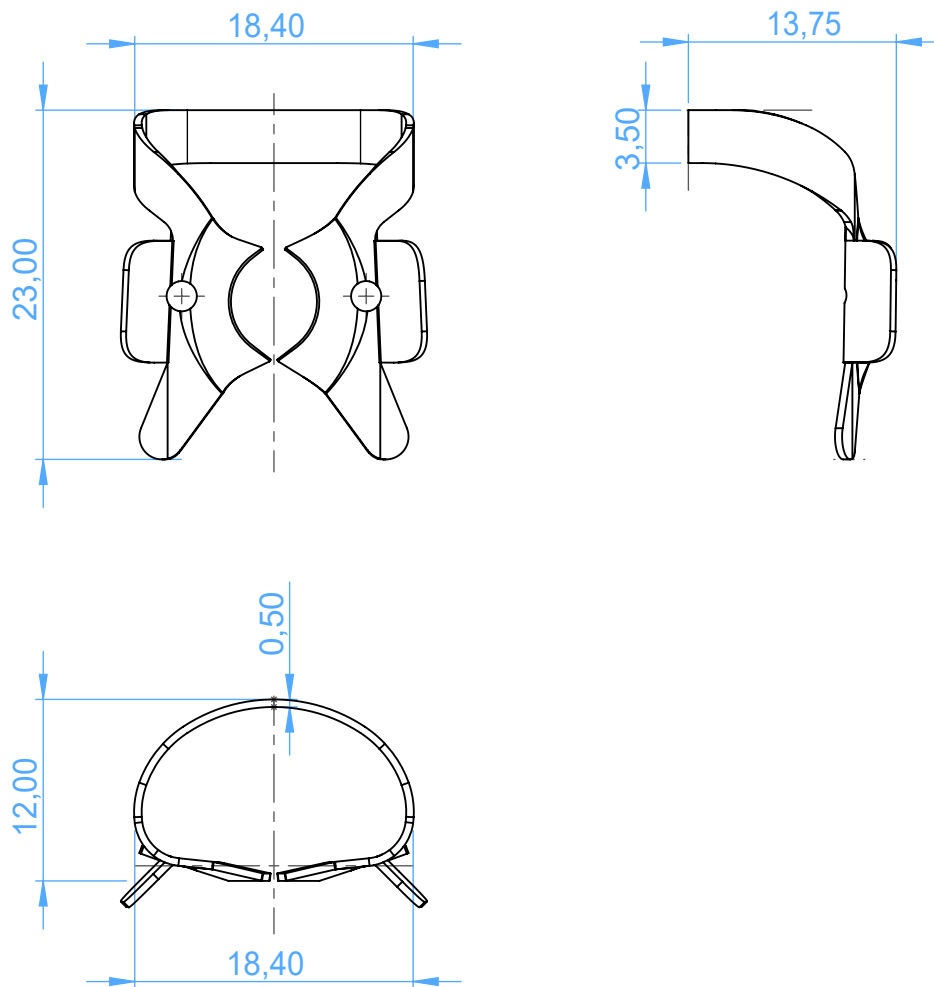

SCALE 2:1