

2801-U3A -
Portaimpronta forati in acciaio inox ANATOMIC /
Perforated stainless steel impression trays ANATOMIC

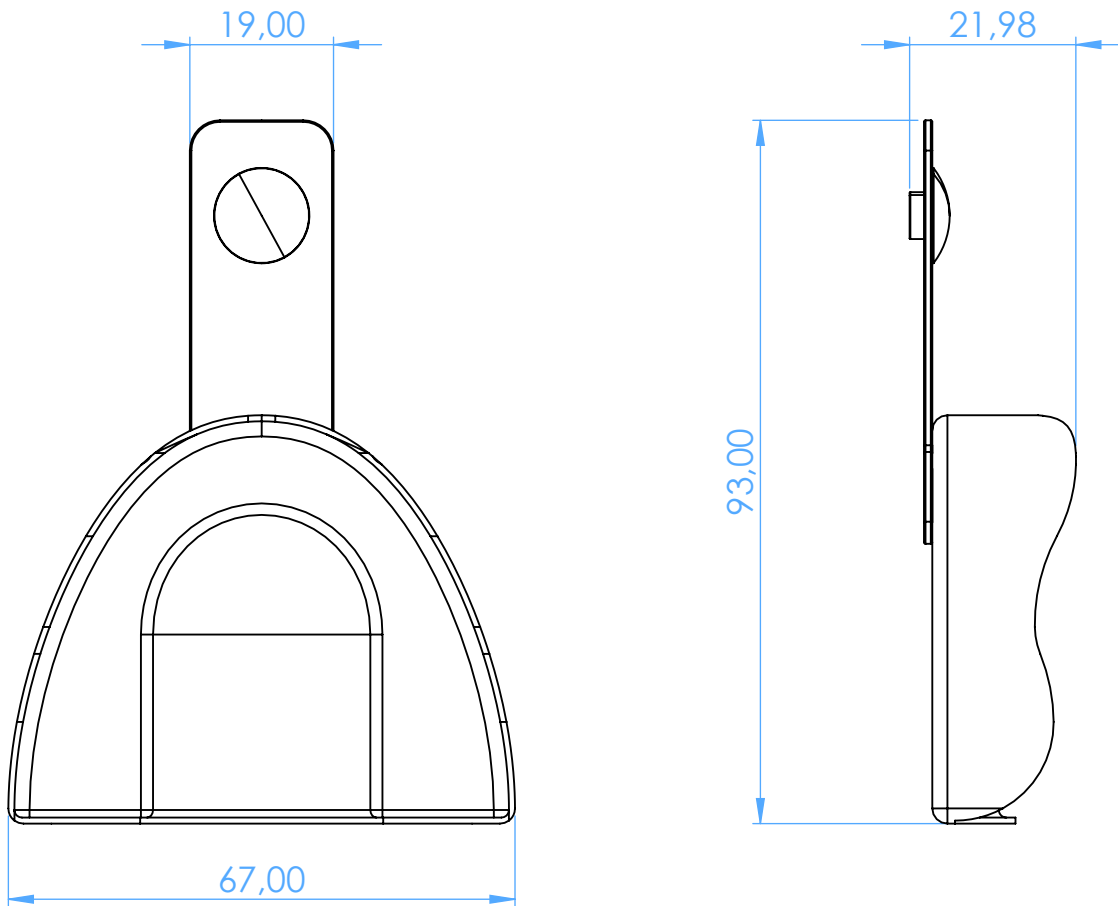

SCALE 1:1