

2802-L2D -
Portaimpronta non forati in acciaio inox / Non-perforated
stainless steel impression trays

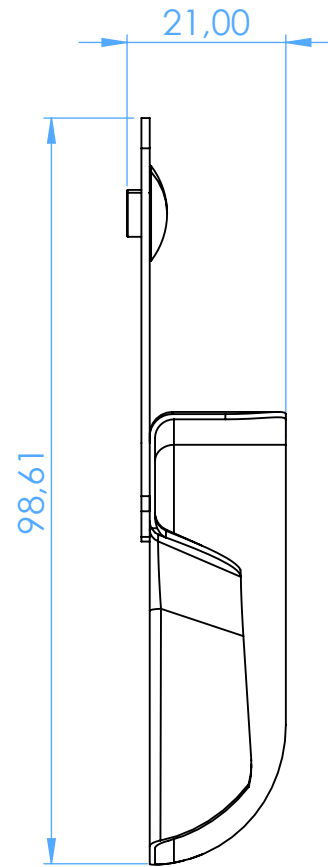
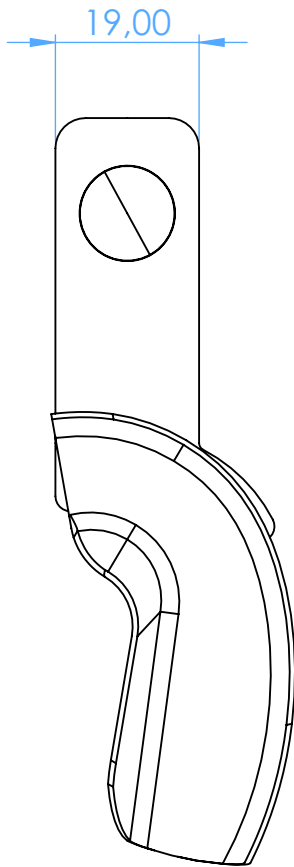

SCALE 1:1