

2802-L4S -
Portaimpronta non forati in acciaio inox / Non-perforated
stainless steel impression trays

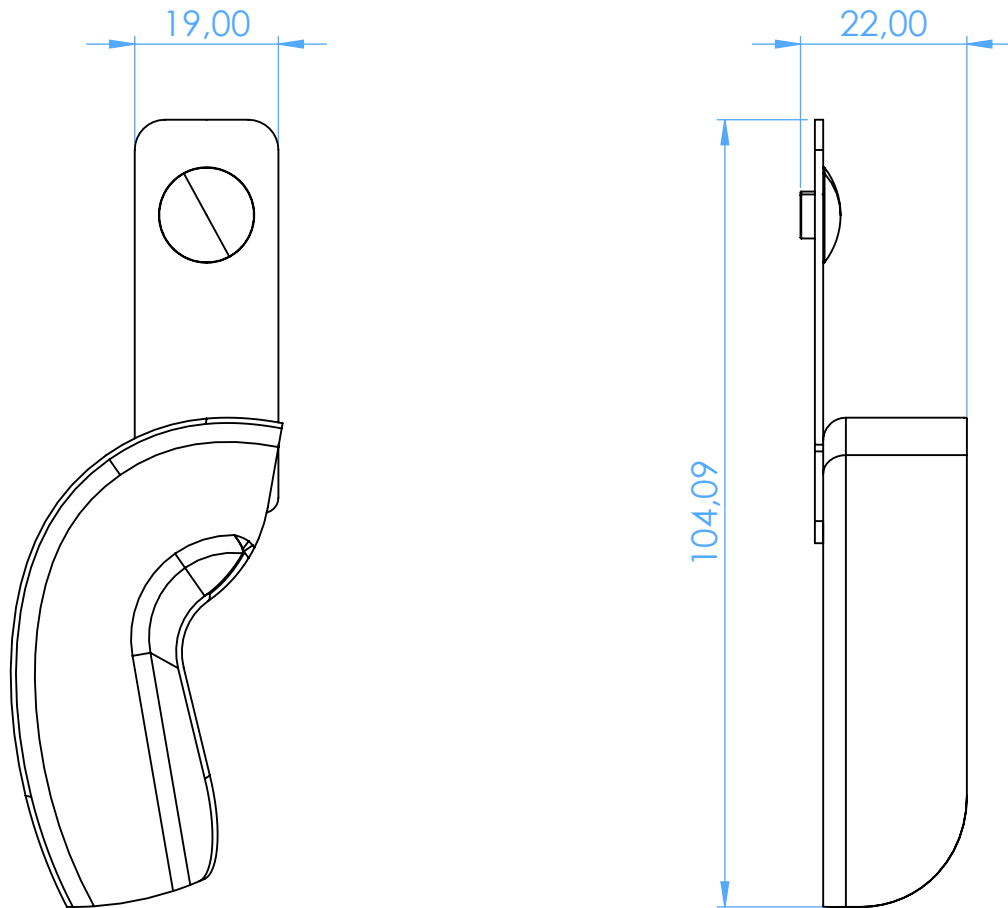

SCALE 1:1