

2802-U3A -  
Portaimpronta non forati in acciaio inox ANATOMIC /  
Non-perforated stainless steel impression trays  
ANATOMIC

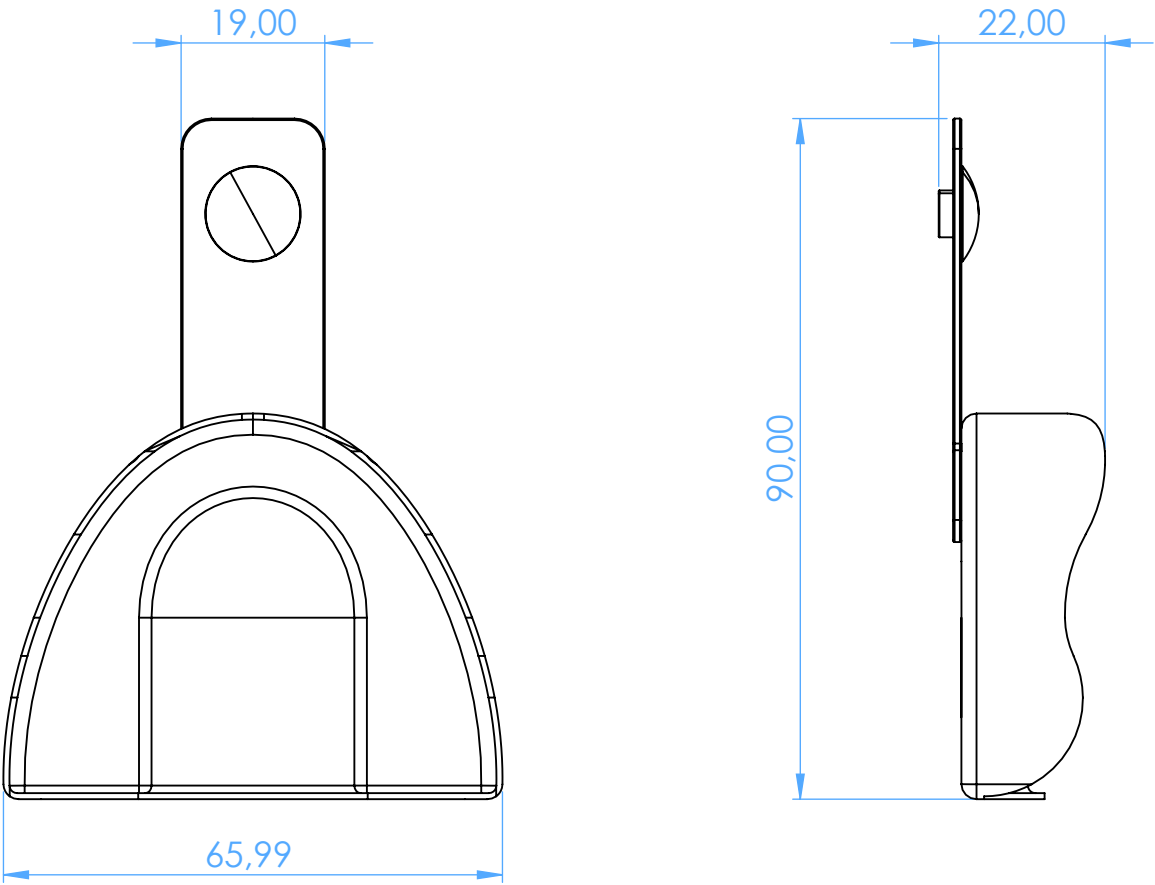

SCALE 1:1