

2802-U3 -
Portaimpronta non forati in acciaio inox / Non-perforated
stainless steel impression trays

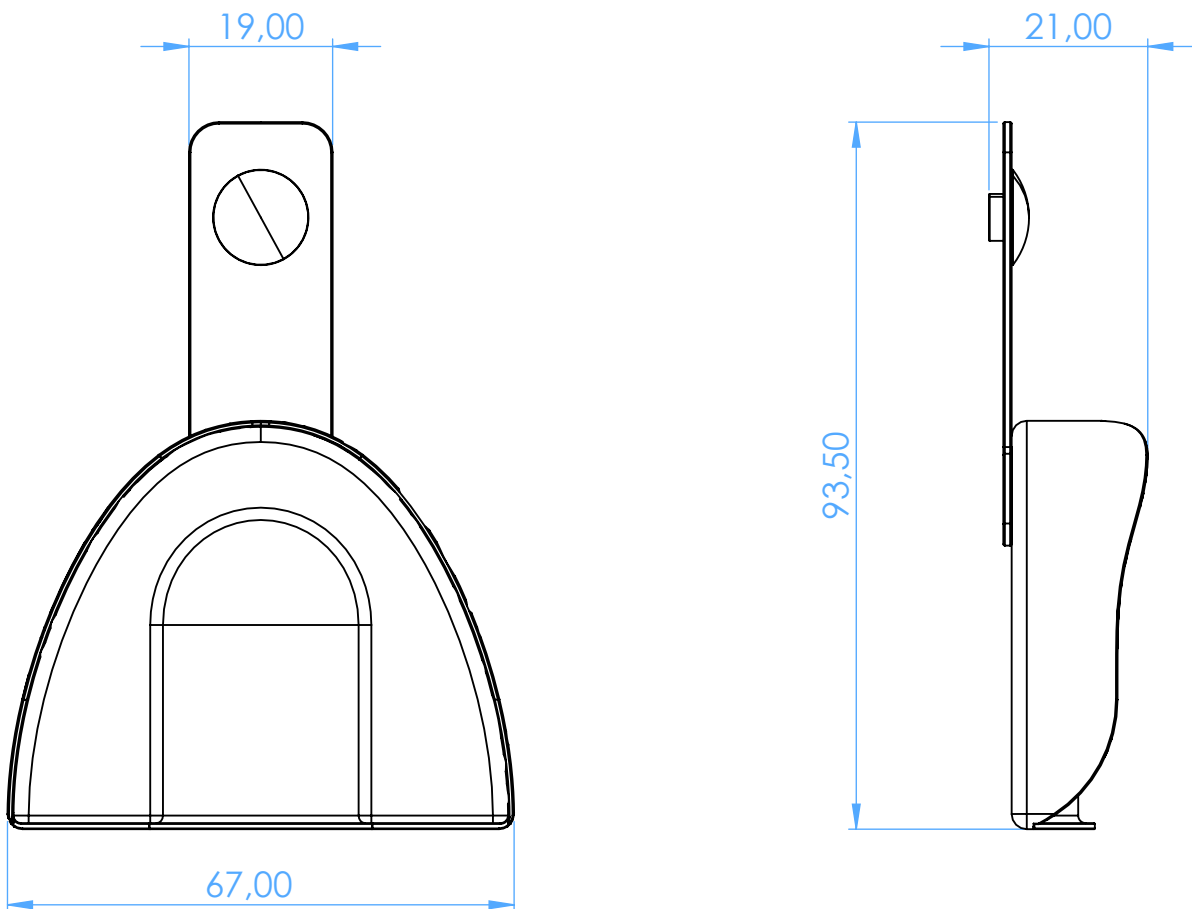

SCALE 1:1