

2802-U4 -  
Portaimpronta non forati in acciaio inox / Non-perforated  
stainless steel impression trays

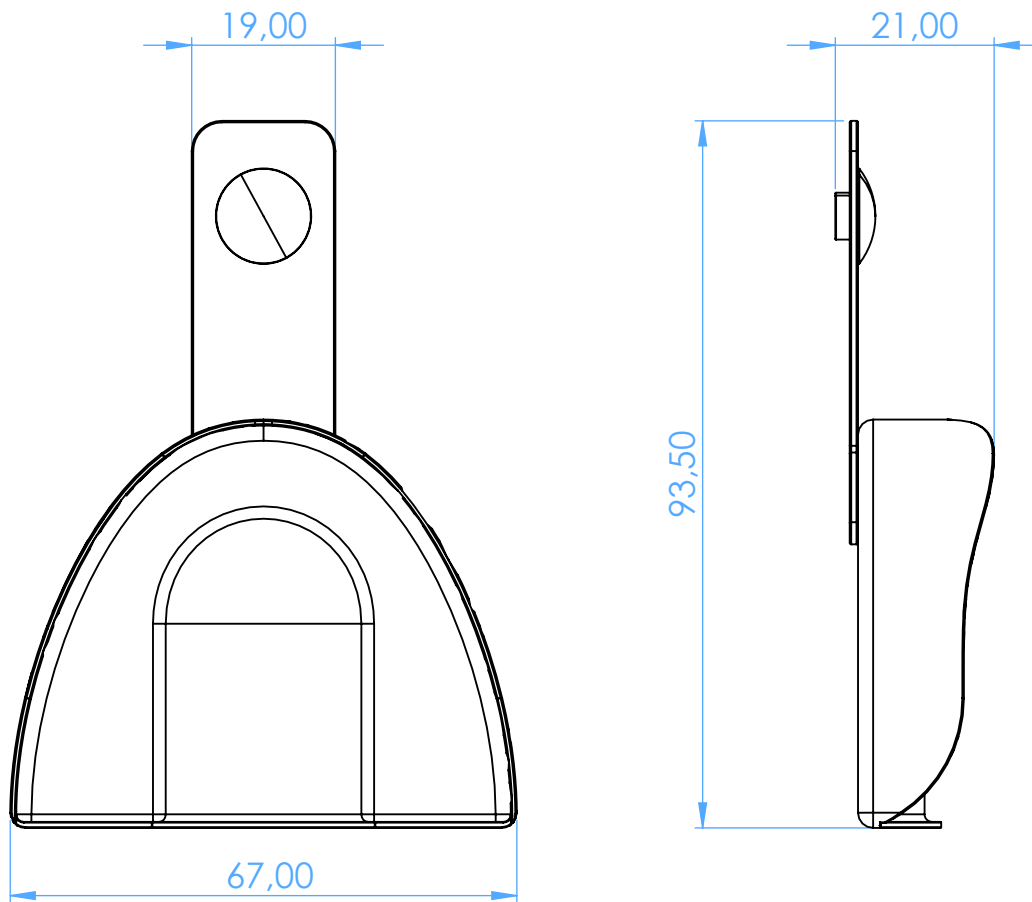

SCALE 1:1