

2802-U6A -
Portaimpronta non forati in acciaio inox ANATOMIC /
Non-perforated stainless steel impression trays
ANATOMIC

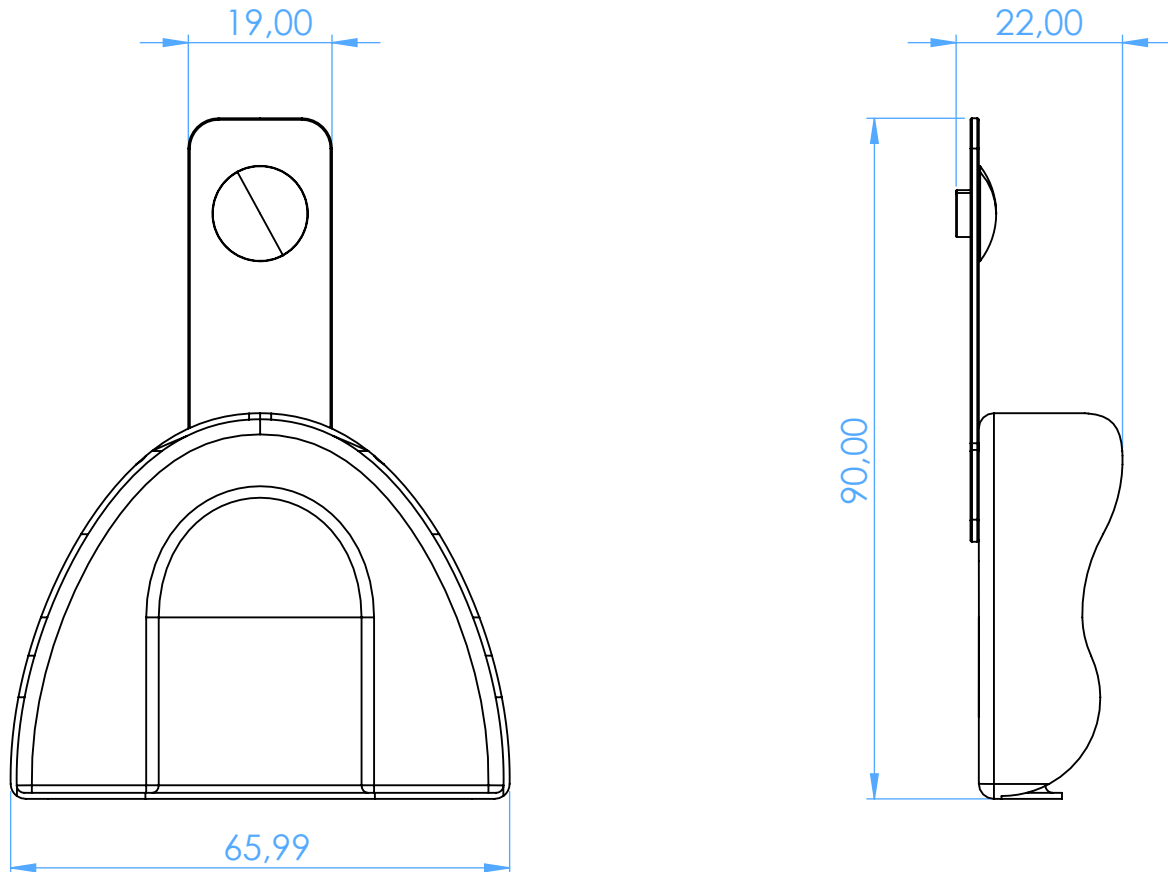

SCALE 1:1