

2804-L6 -  
Portaimpronta forati in acciaio inox - PERMA-LOCK /  
Perforated stainless steel impression trays - PERMA-LOCK

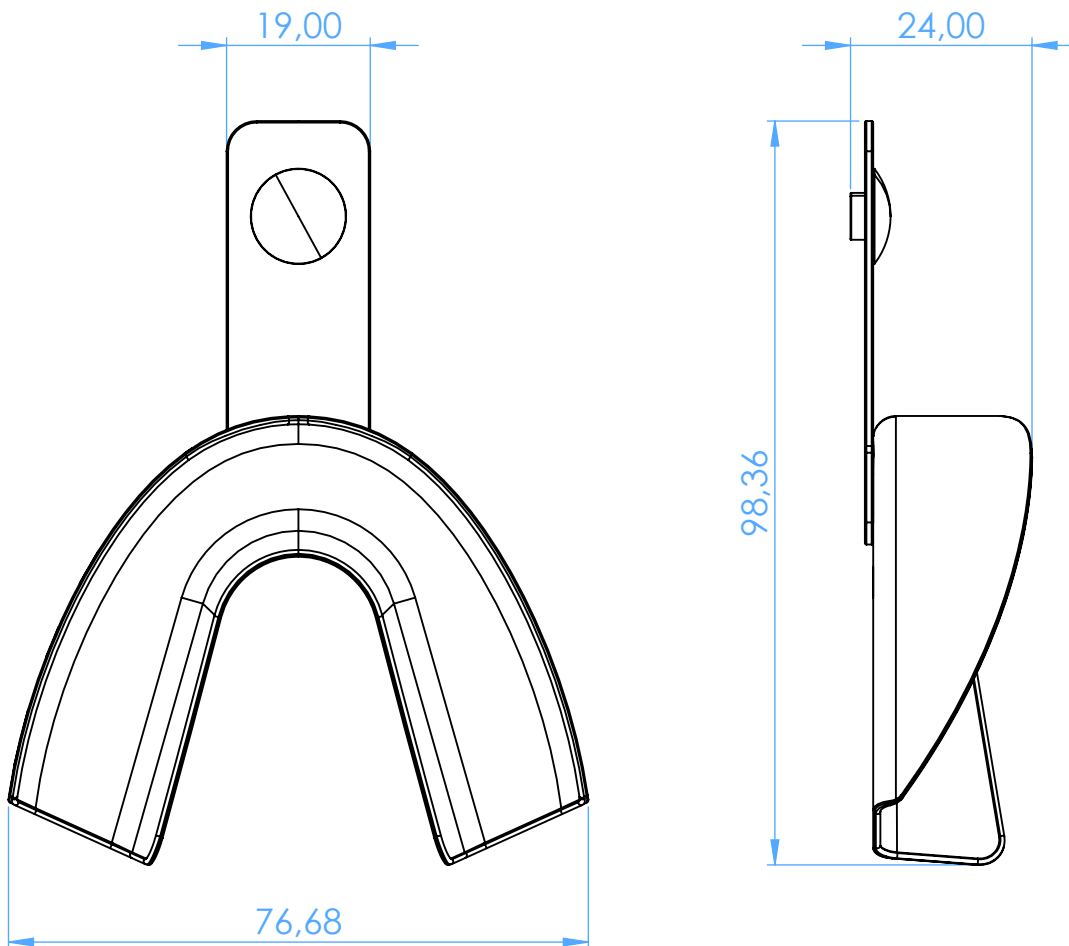

SCALE 1:1