

2804-U5A -
Portaimpronta forati in acciaio inox -PERMA-LOCK
anatomic / Perforated stainless steel impression trays -
PERMA-LOCK ANATOMIC

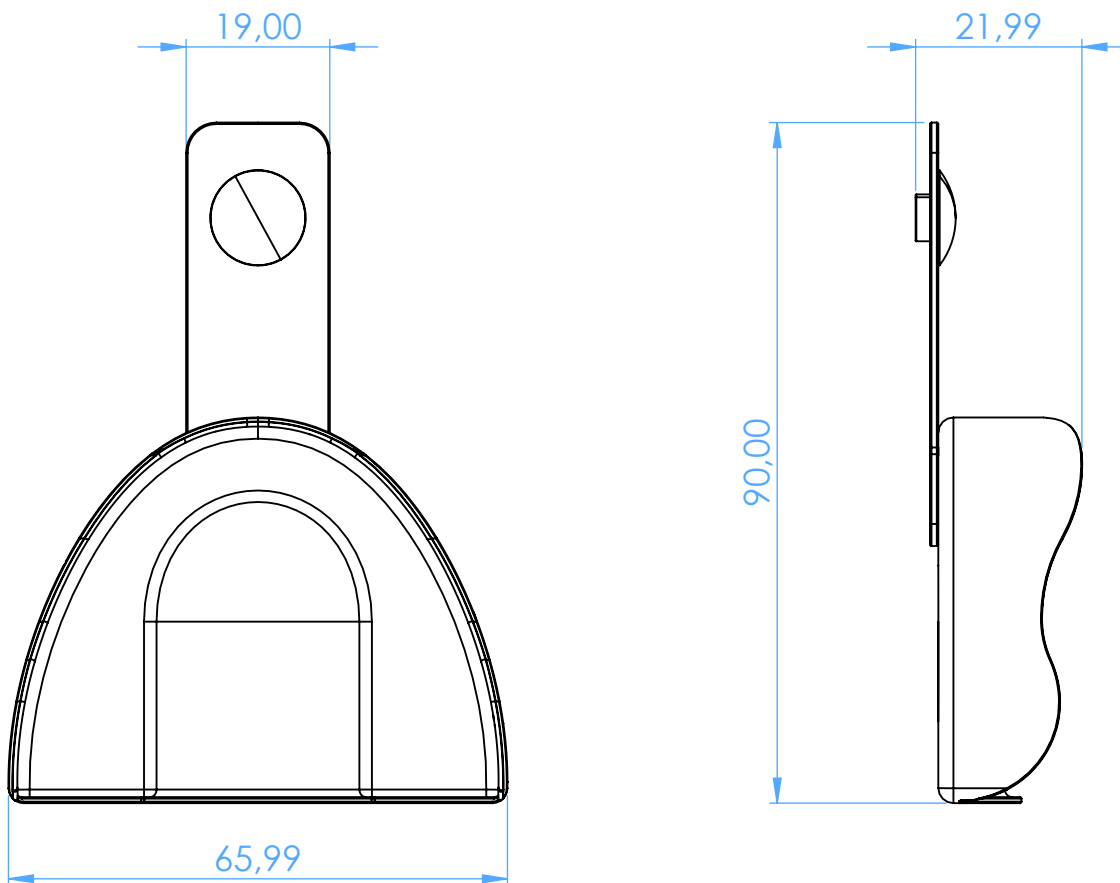

SCALE 1:1