

2804-U6A -  
Portaimpronta forati in acciaio inox -PERMA-LOCK  
anatomic / Perforated stainless steel impression trays -  
PERMA-LOCK ANATOMIC

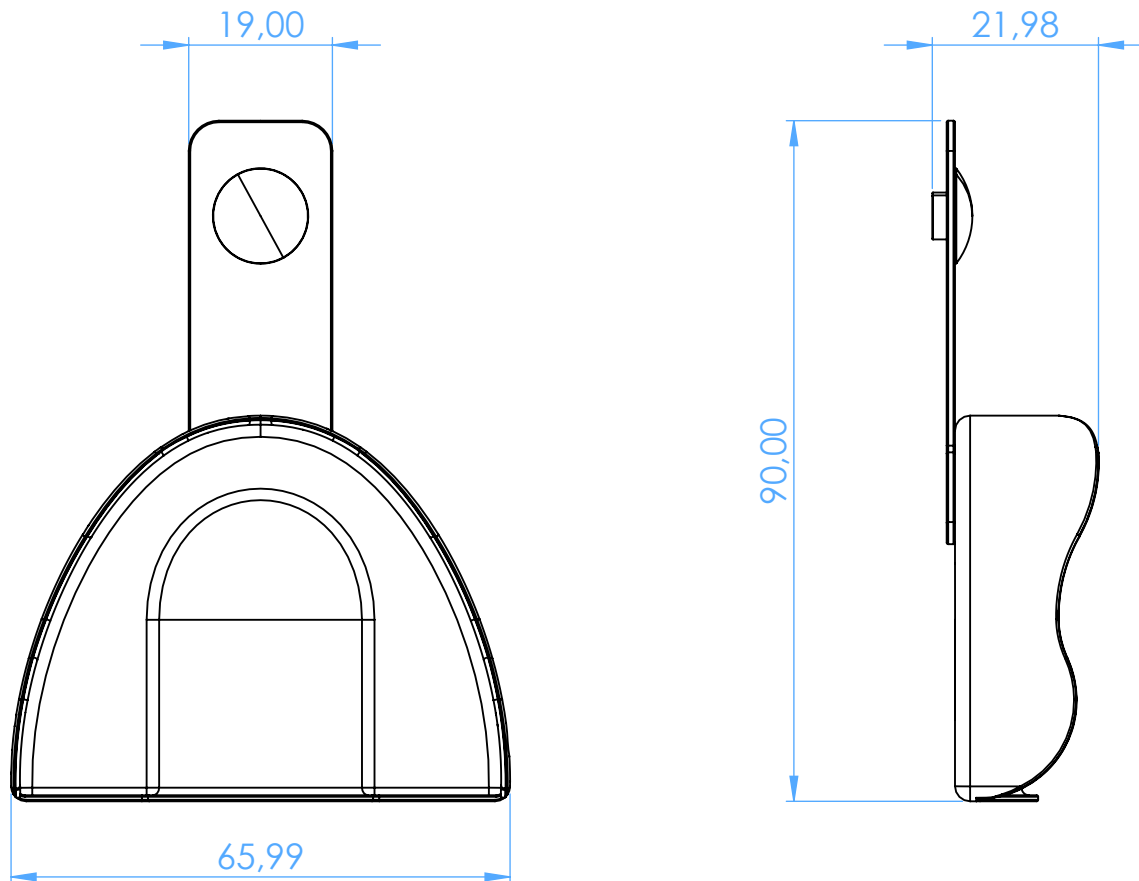

SCALE 1:1