

2804S-L5 -
Portaimpronta forati in acciaio inox - PERMA-LOCK HIGH
GRIP / Perforated stainless steel impression trays -
PERMA-LOCK high grip

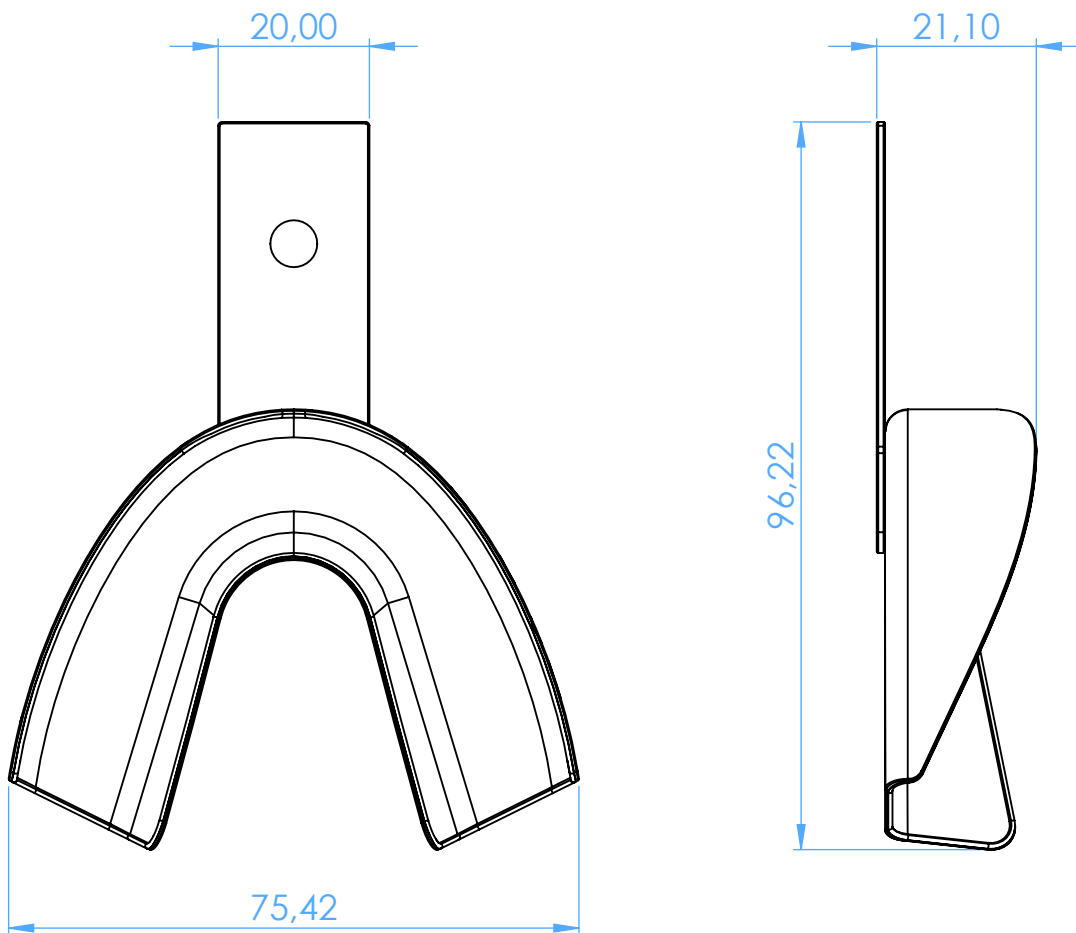

SCALE 1:1