

2807-L6D -
Portaimpronta non forati in acciaio inox - PERMA-LOCK /
Non-perforated stainless steel impression trays -
PERMA-LOCK

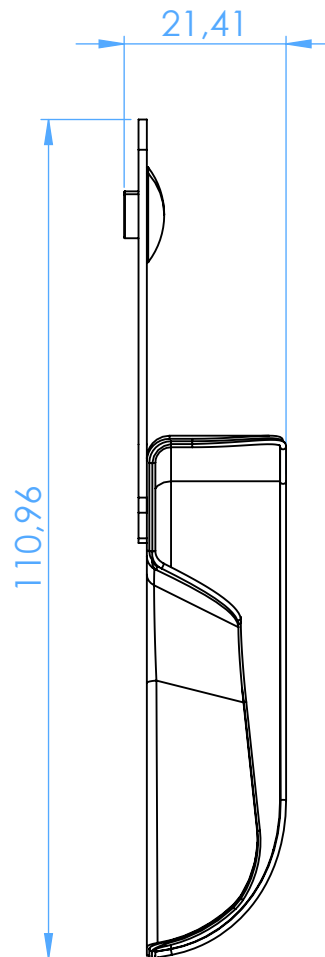
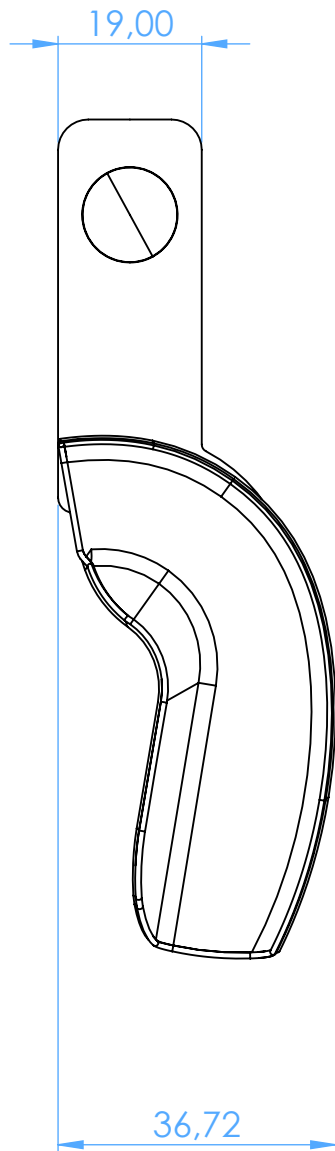

SCALE 1:1