

2807-L6 -
Portaimpronta non forati in acciaio inox - PERMA-LOCK
/Non-perforated stainless steel impression trays -
PERMA-LOCK

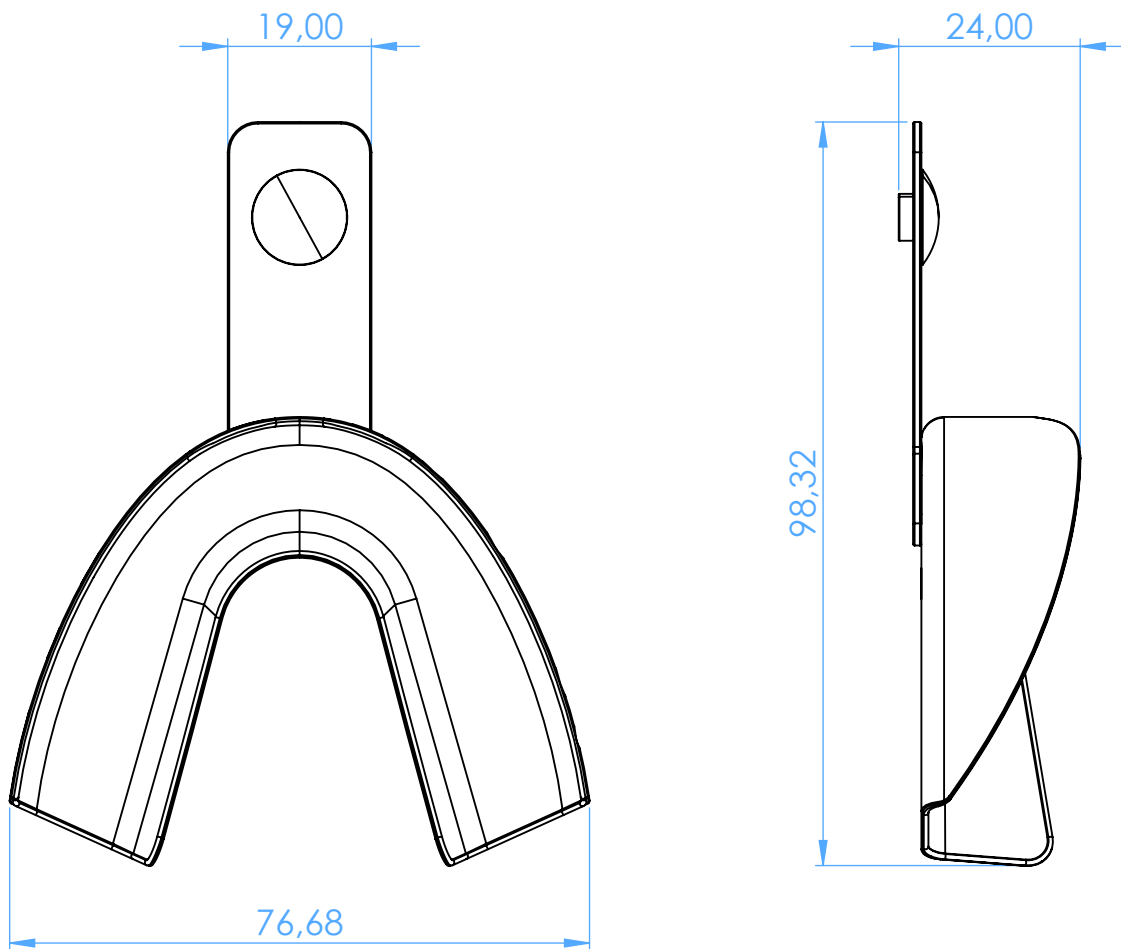

SCALE 1:1