

2807-U2A -
Portaimpronta non forati in acciaio inox - PERMA-LOCK
ANATOMIC / Non-perforated stainless steel impression
trays - PERMA-LOCK ANATOMIC

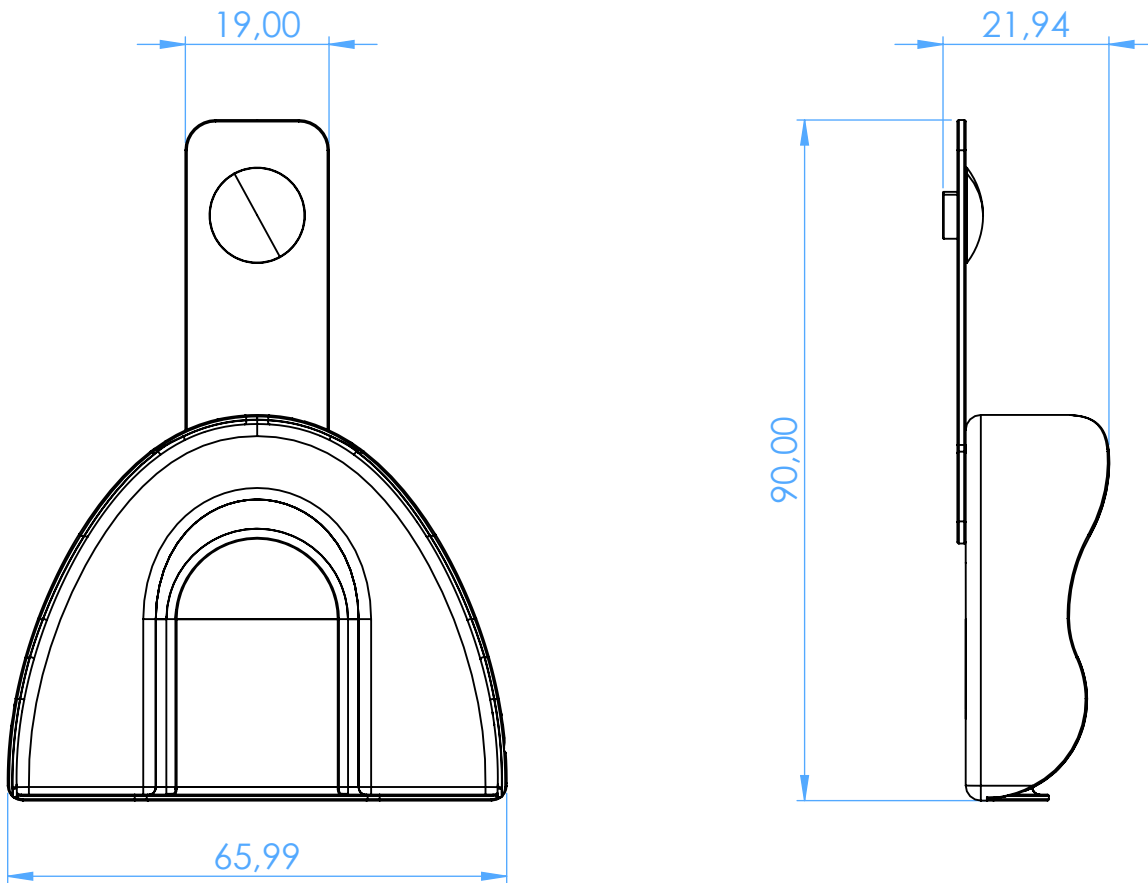

SCALE 1:1