

2807-U4A -
Portaimpronta non forati in acciaio inox - PERMA-LOCK
ANATOMIC / Non-perforated stainless steel impression
trays - PERMA-LOCK anatomic

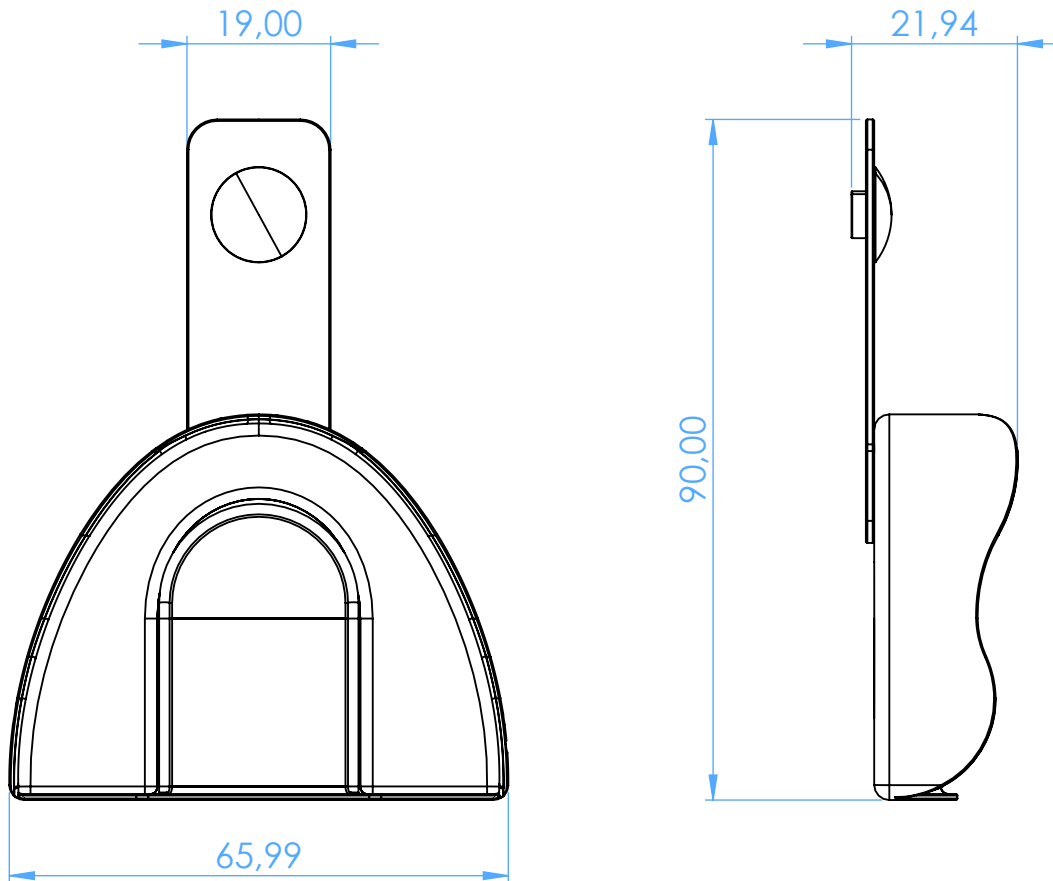

SCALE 1:1