

2807S-L5 -
Portaimpronta non forati in acciaio inox - PERMA-LOCK
HIGH GRIP / Non-perforated stainless steel impression
trays - PERMA-LOCK HIGH GRIP

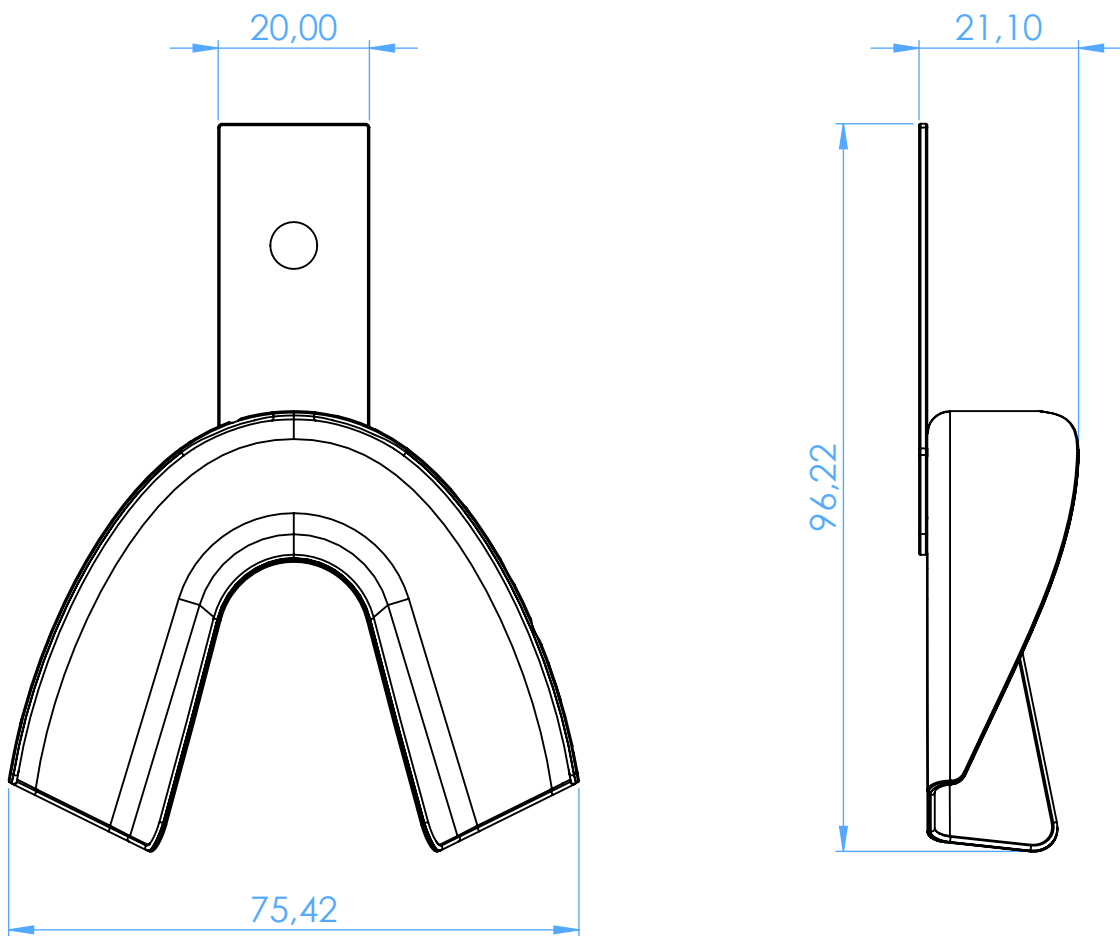

SCALE 1:1