

2810-U7 -
Portaimpronta non forati in acciaio inox - depressi
anteriormente / Non-perforated stainless steel
impression trays - anterior depressed

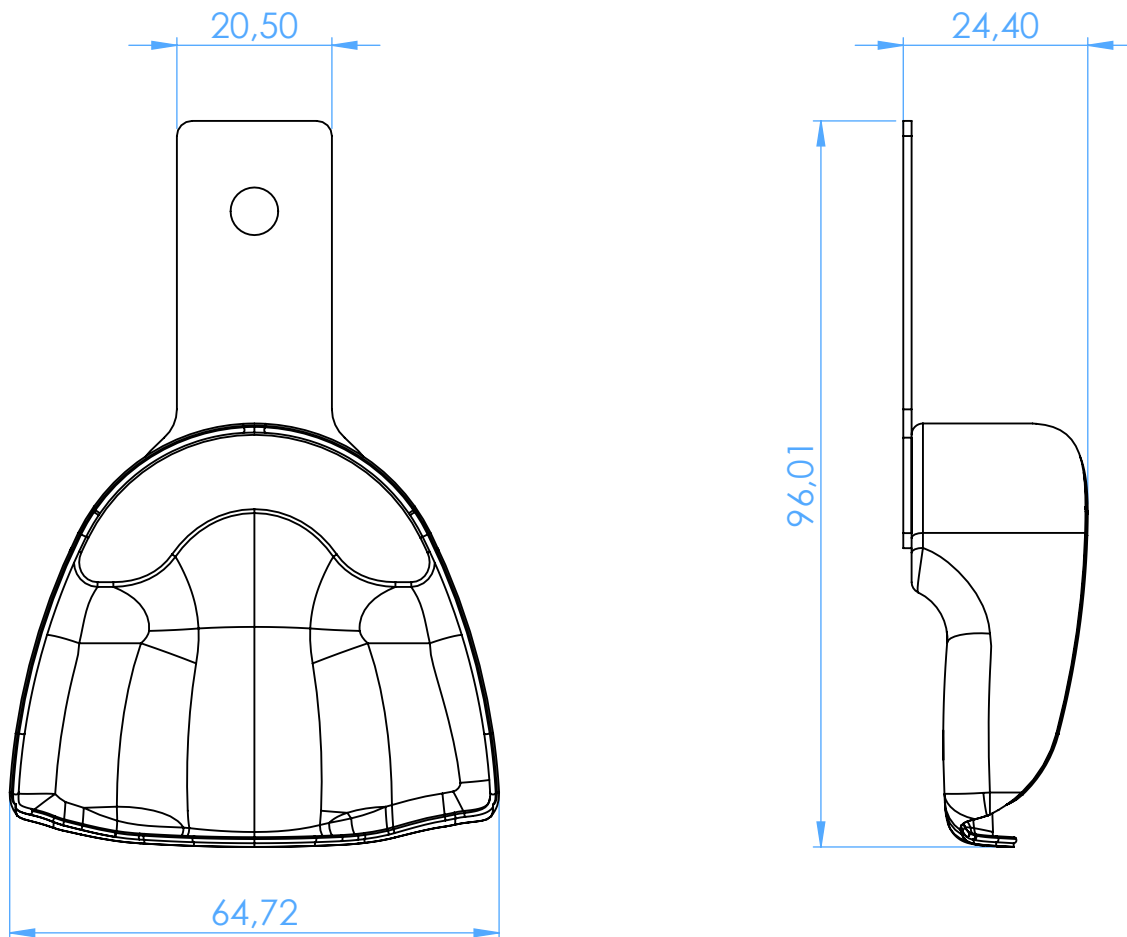

SCALE 1:1