

2813-L3 -
Portaimpronta forati in acciaio inox - edentuli /
Perforated stainless steel impression trays - edentulous

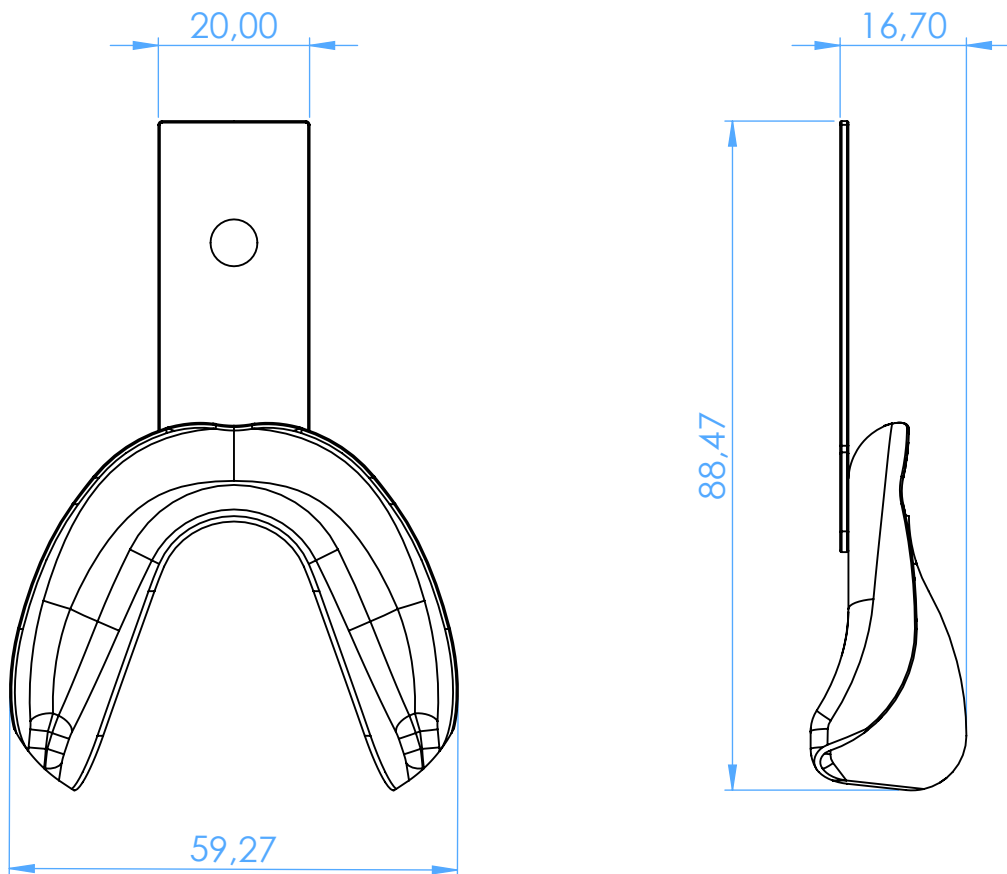

SCALE 1:1