

2814-L4 -
Portaimpronta forati in alluminio colorate per
implantologia / Perforated colour-coded aluminum
impression trays for implantology

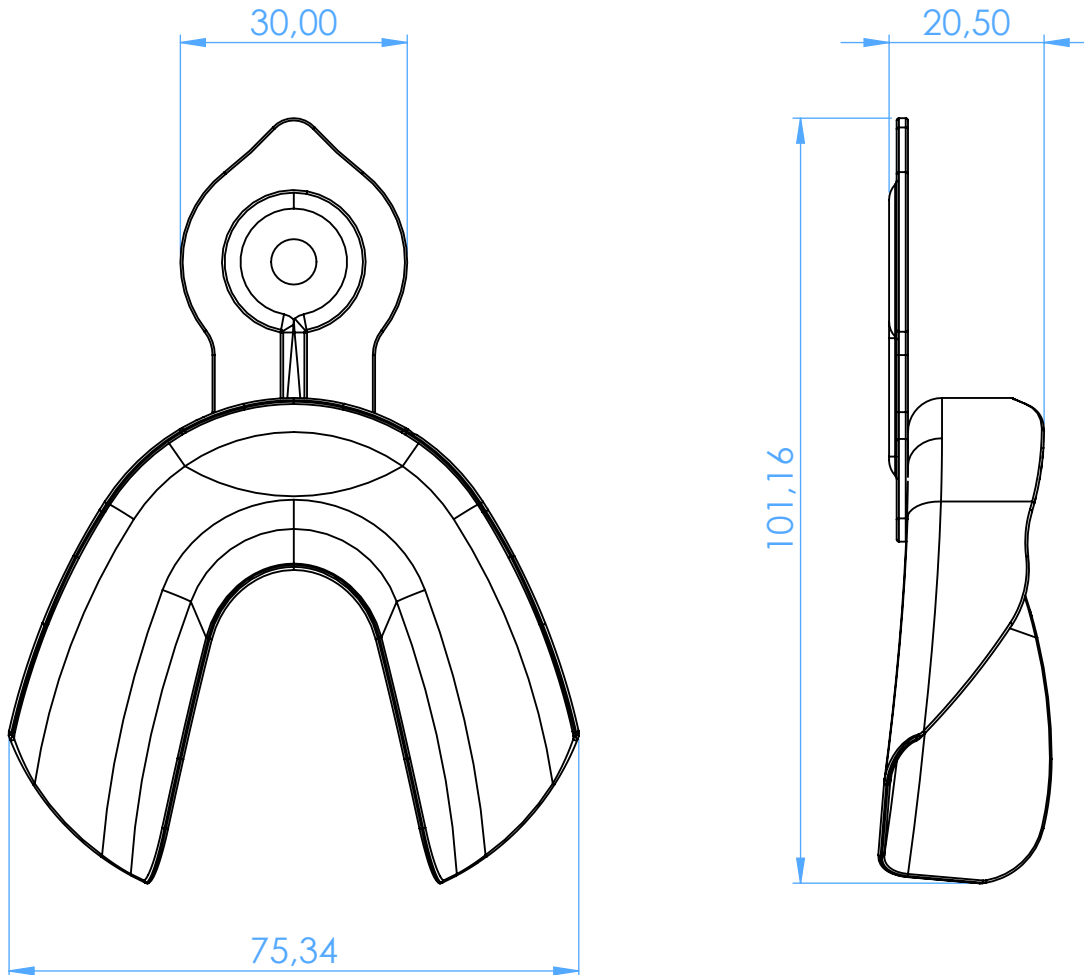

SCALE 1:1