

2880-L4 -
Portaimpronta forati in alluminio per implantologia /
Perforated aluminum impression trays for implantology

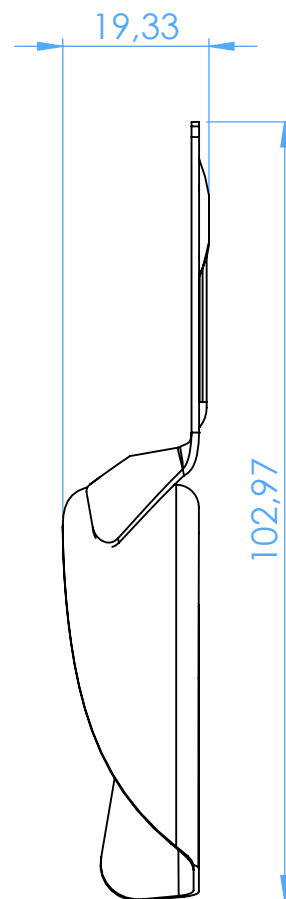
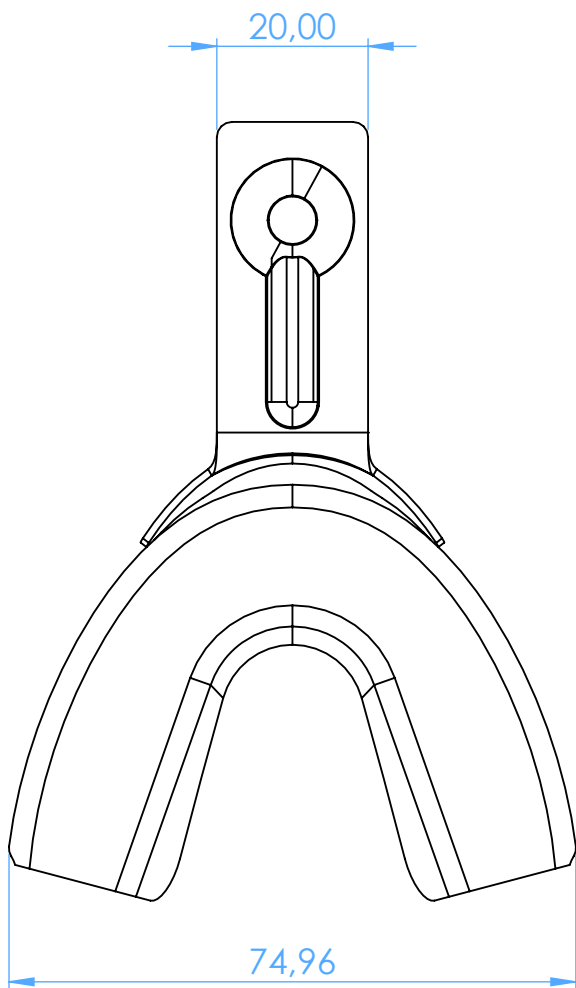

SCALE 1:1