

2880-L6 -
Portaimpronta forati in alluminio per implantologia /
Perforated aluminum impression trays for implantology

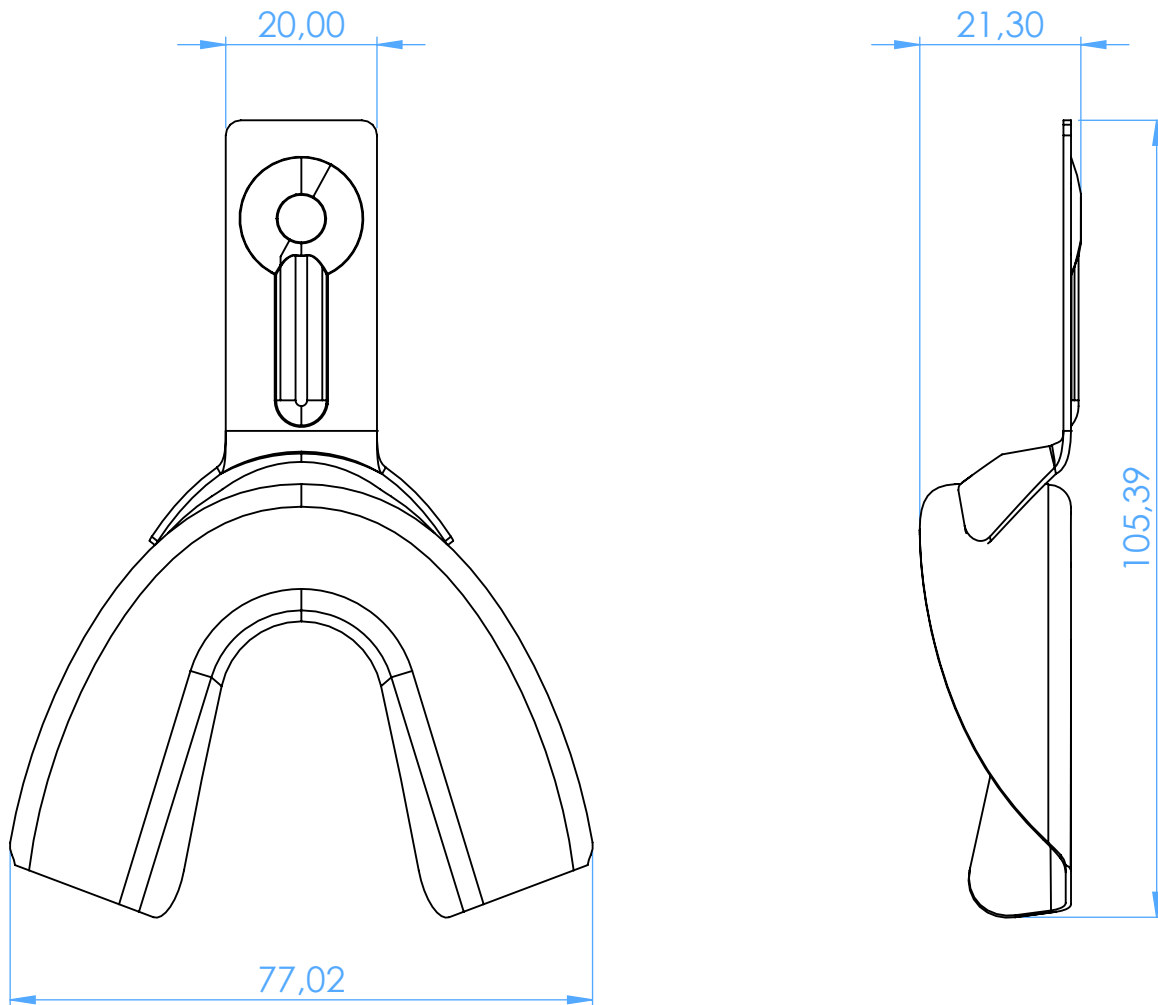

SCALE 1:1