

2904-8 - SURGICAL STAINLESS STEEL SALIVA EJECTORS / Cannula Chirurgica in Acciaio Inox

8FR Frazier - Ø 2,7 mm - 15 cm

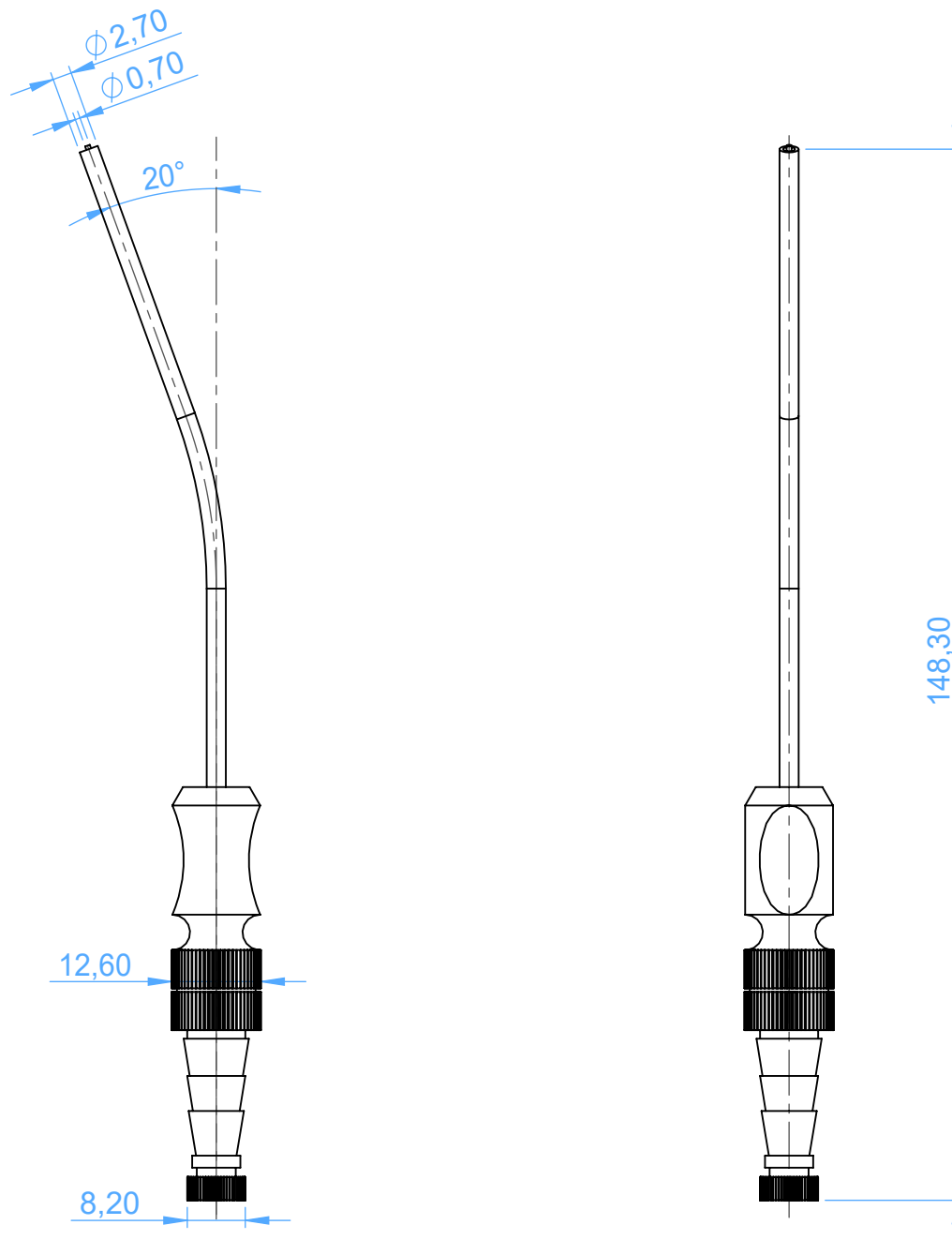

SCALE 1:1

ASA DENTAL
MAKE PEOPLE SMILE