

3051-26 - RUBBER DAM CLAMPS / Uncini per diga

26
wingless
for upper molars

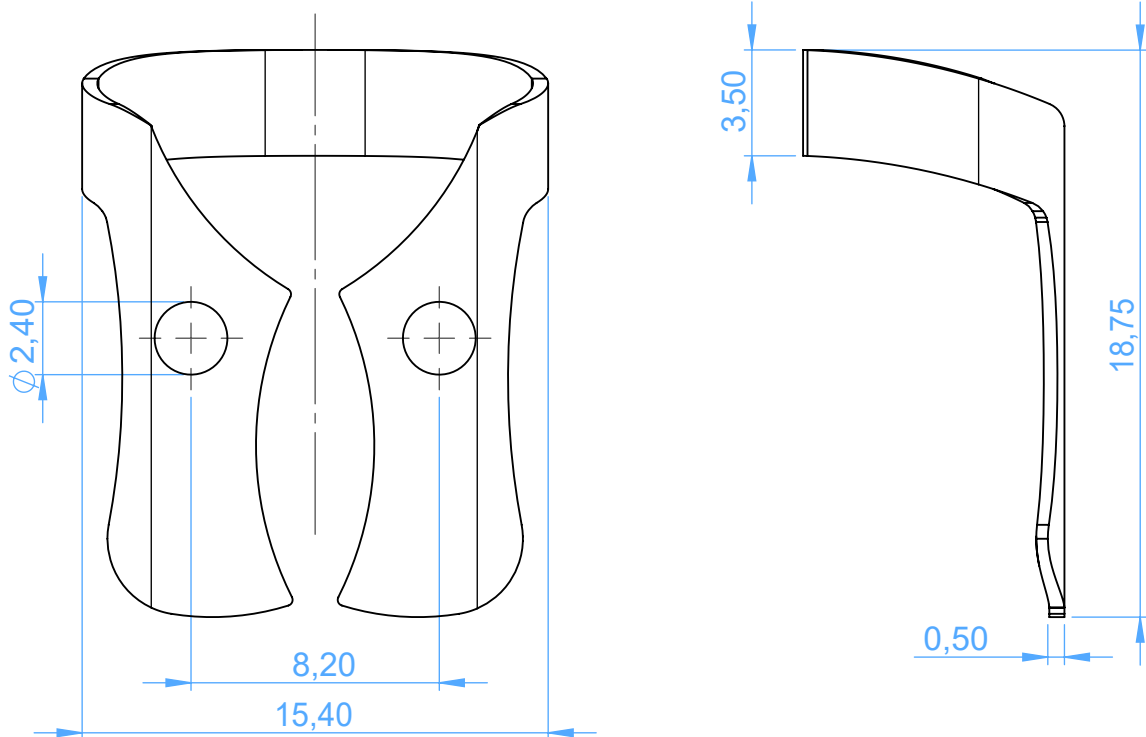

SCALE 4:1