

3052-4 - RUBBER DAM CLAMPS / Uncini per diga

4
winged

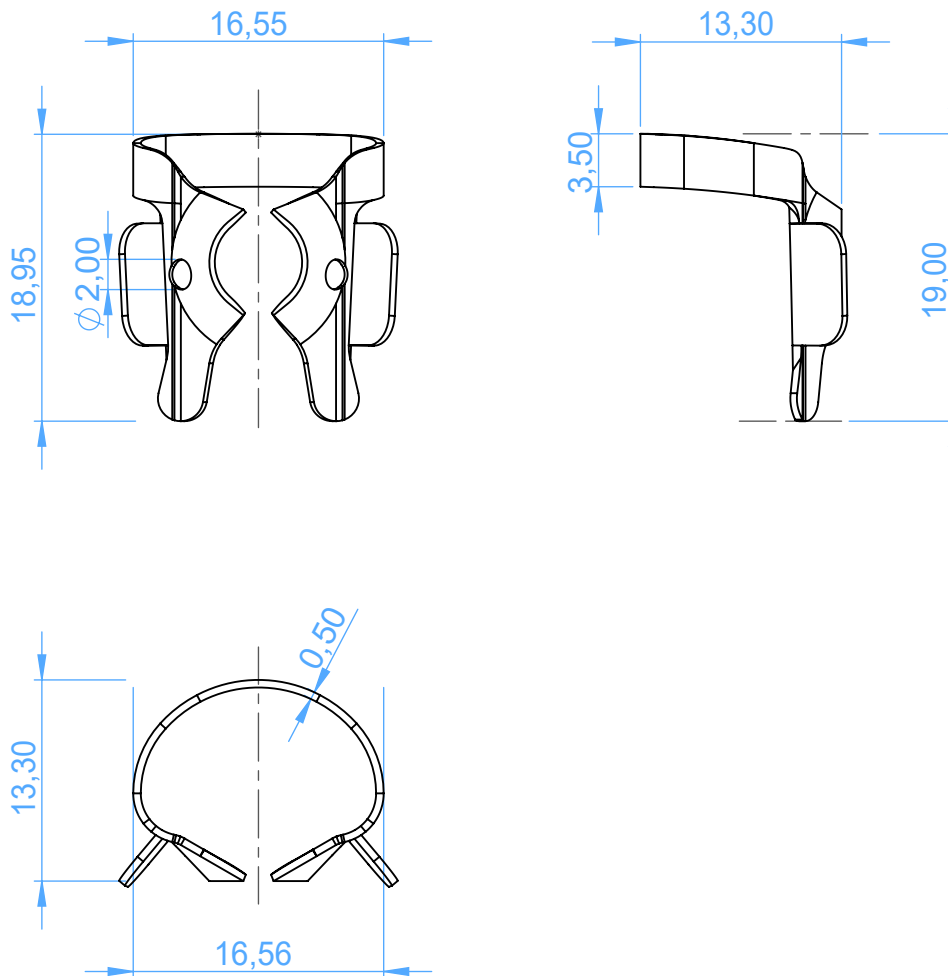

SCALE 2:1