

AL2741-2 - Contenitore per Endodonzia - Endodontic box

MEDIUM

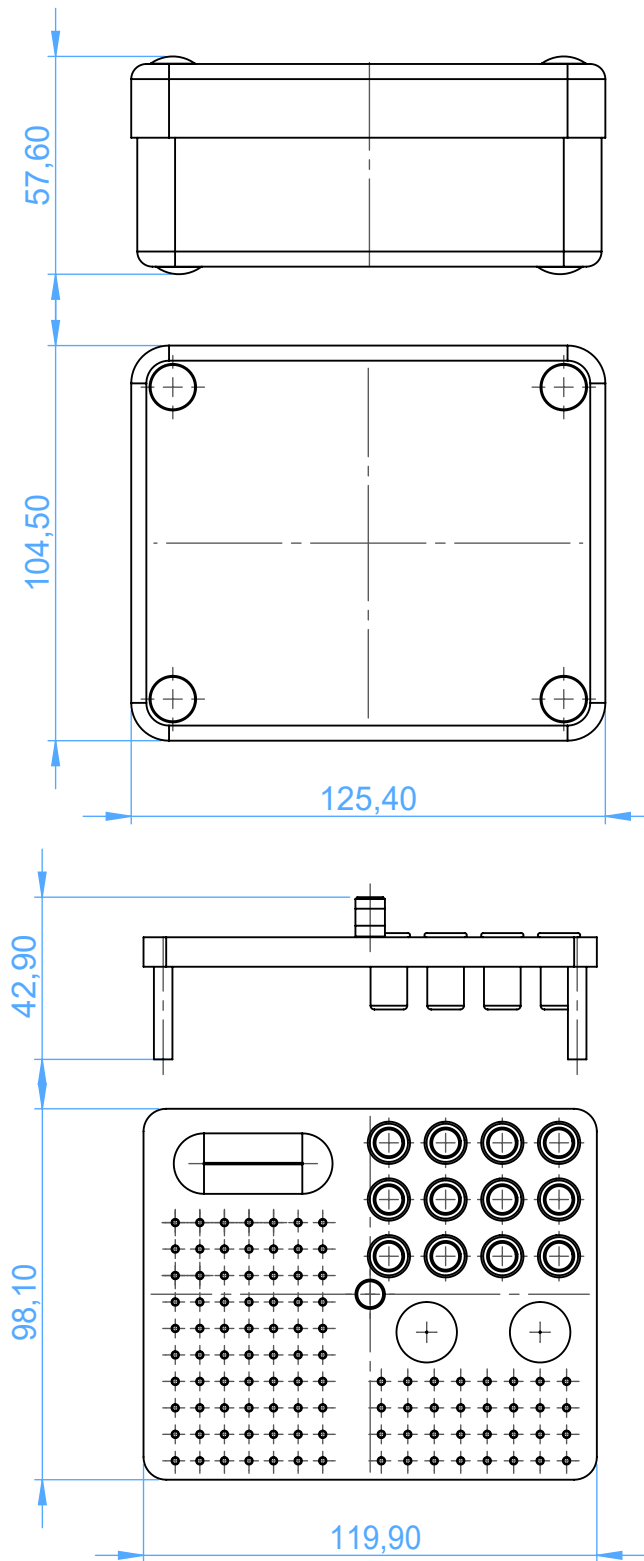

SCALE 1:2