

AL2742-1 - Contenitore per Endodonzia - Endodontic box

MINI

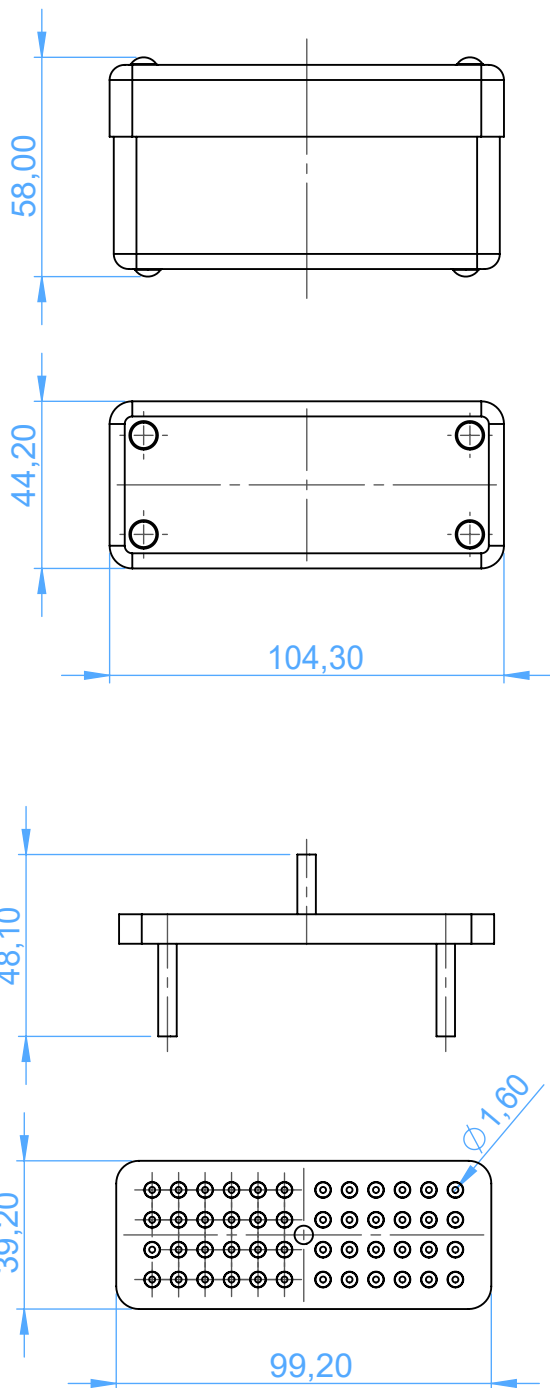

SCALE 1:2