

AL2742-3 - Contenitore per Endodonzia - Endodontic box

MINI

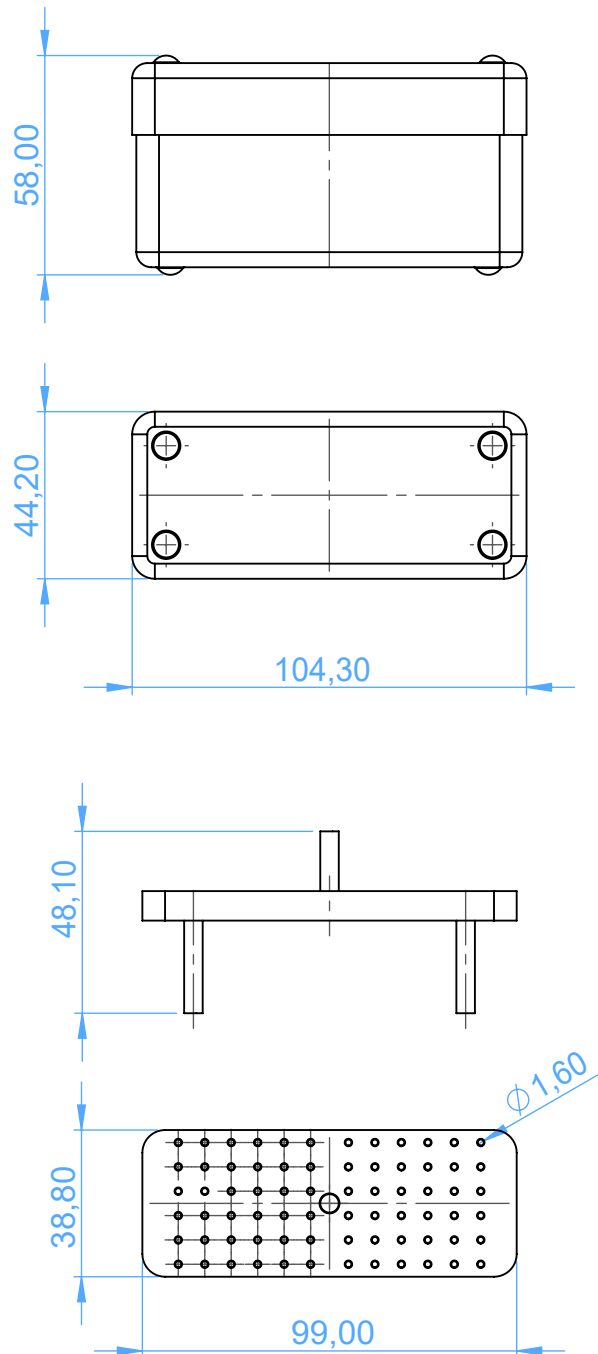

SCALE 1:2