

AL2742-5 - Contenitore per Endodonzia - Endodontic box

MINI

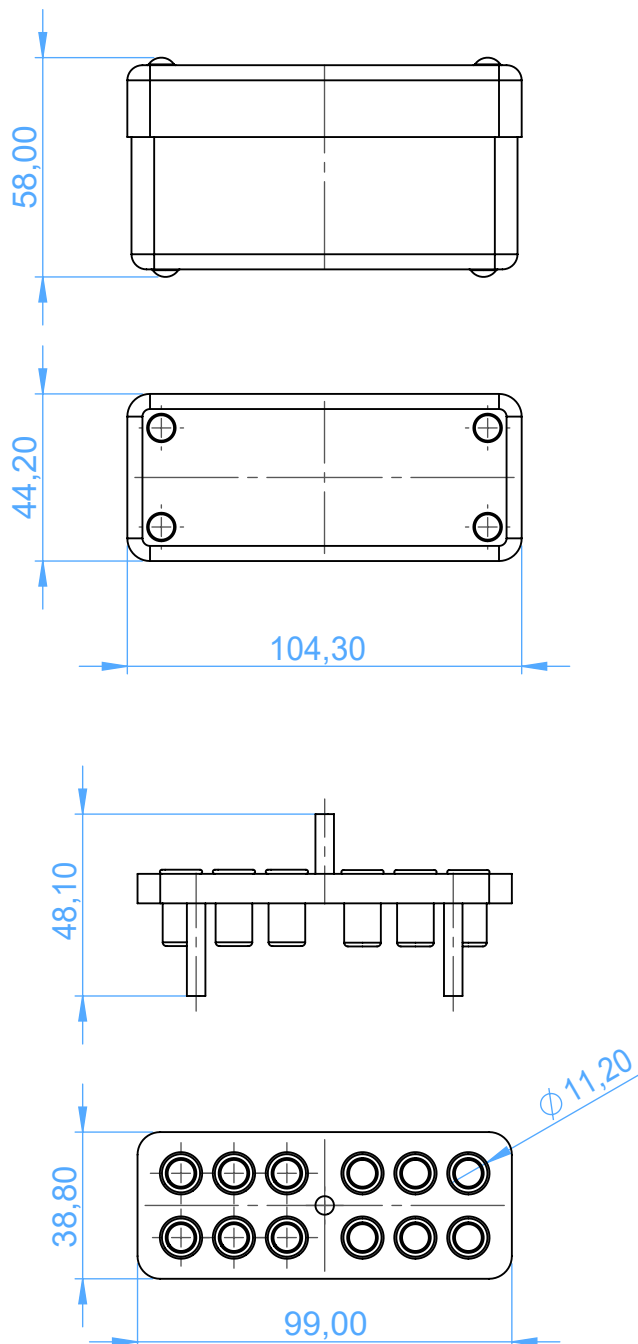

SCALE 1:2